

VESSEL HOLDERS & STAGE PLATES

All models

AMEP-VH001

holds two 25mm x 75mm standard microscope slides, chamber slides, etc.

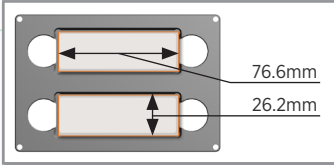

AMEP-VH002

holds four 35mm Petri dishes

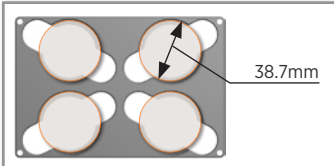

AMEP-VH003

holds two 60mm Petri dishes

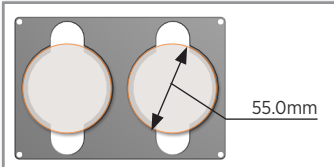

AMEP-VH004

holds one 100mm Petri dish

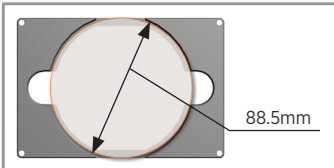

AMEP-VH005

holds two 25cm² flasks; rectangular or triangular

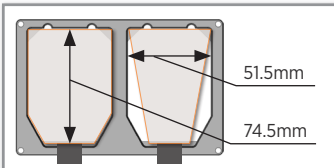

AMEP-VH006

holds one Nunc T-75 flask; 75cm²

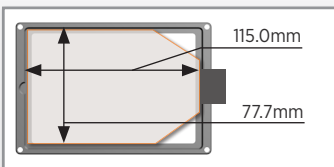

AMEP-VH007

holds one Hemocytometer

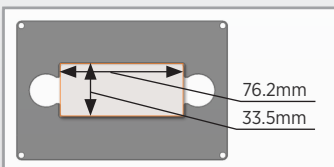

AMEP-VH008

holds one Greiner T-75 flask; 75cm²

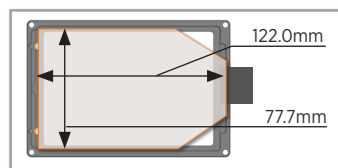

AMEP-VH009

Universal stage insert

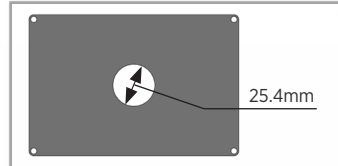

AMEP-VH010

holds one BD/Greiner T-25 flask; 25cm²

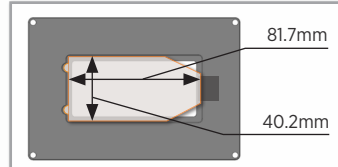

AMEP-VH011

holds one NUNC/SPL IVF 4-well dish

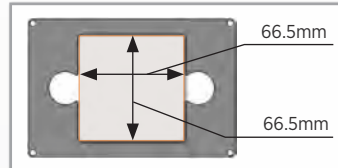

AMEP-VH012

holds one SPL T-75 flask; 75cm²

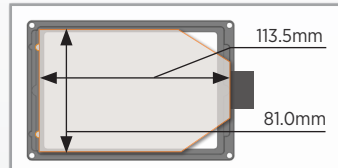

AMEP-VH013

holds four Ibidi 35mm Petri dishes

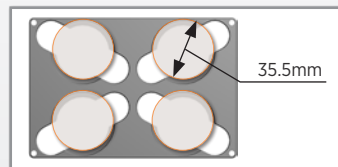

AMEP-VH014

holds two Ibidi 50mm Petri dishes

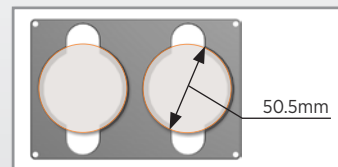

AMEP-VH017

holds one KOVA Glasstic Slide 10

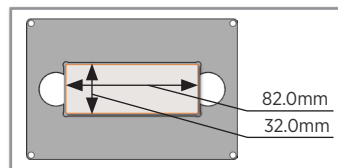

AMEP-VH018

holds one Nunc T-25 flask; 25cm²

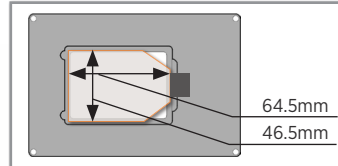

FL Auto

AMEP-VH021

Securely holds two 25mmx75mm standard microscope slides, chamber slides, etc

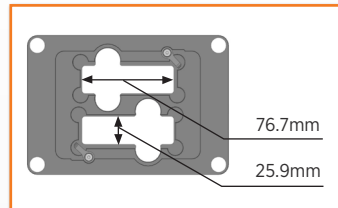

AMEP-VH022

Intermediate Plate for Automated Stage. Securely holds multi-well vessels with convenient lever Adaptor for AMEP-VH001 and AMEP-VH009

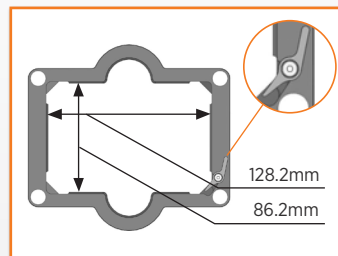

AMEP-VH023

holds multi-well vessels
Adaptor for AMEP-VH001 and AMEP-VH009

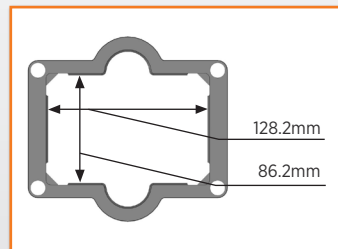

FL & XL

AMEP-4684

Stage Plate for heating tray, Tokai Hit #MATS-UAXKW-D

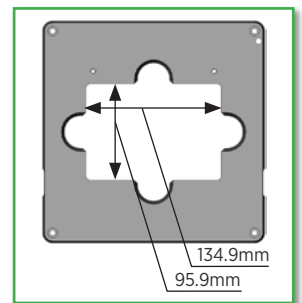

AMEP-4685

Stage Plate for heating stage, BioFlux by Fluxion

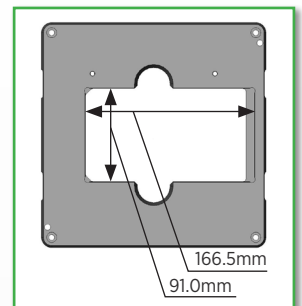

AMEP-4686

Stage Plate for multi-well vessels; also holds one Corning T-75 flask

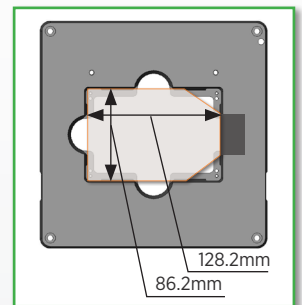

AMEP-4691

Stage Plate with 110m x 160mm opening (Use with AMEP-4692 for standard sizes)

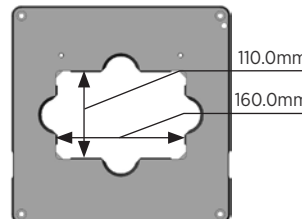

AMEP-4692

Stage Plate Adaptor 110mm x 160mm opening for standard size (sold separately)

