

## All models

### AMEPVH001

holds two 25mm x 75mm standard microscope slides, chamber slides, etc.

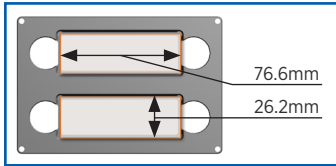

### AMEPVH008

holds one Greiner T-75 flask; 75cm²

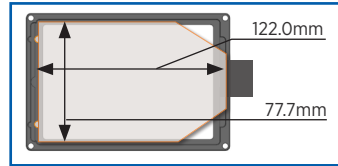

### AMEPVH017

holds one KOVA Glasstic Slide 10

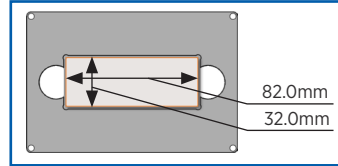

### AMEPVH002

holds four 35mm Petri dishes

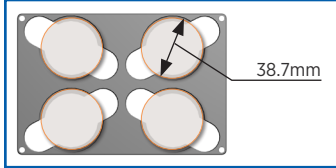

### AMEPVH009

Universal stage insert

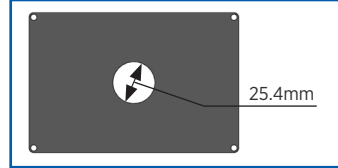

### AMEPVH018

holds one Nunc T-25 flask; 25cm²

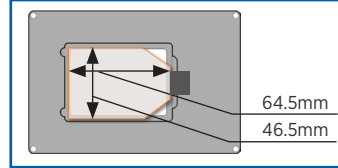

### AMEPVH003

holds two 60mm Petri dishes

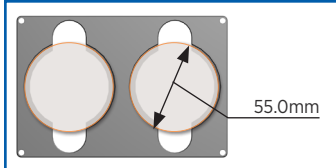

### AMEPVH010

holds one BD/Greiner T-25 flask; 25cm²

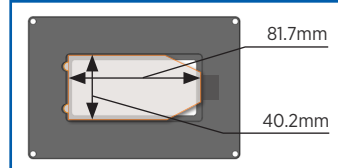

### AMEPVH004

holds one 100mm Petri dish

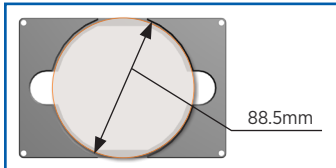

### AMEPVH011

holds one NUNC/SPL IVF 4-well dish

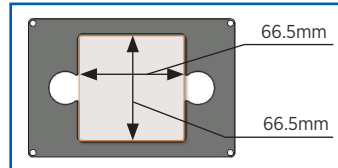

### AMEPVH005

holds two 25cm² flasks; rectangular or

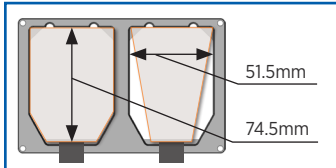

### AMEPVH012

holds one SPL T-75 flask; 75cm²

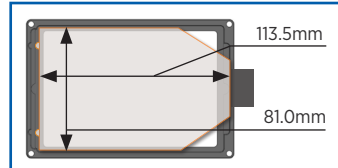

### AMEPVH006

holds one Nunc T-75 flask; 75cm²

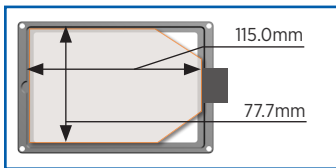

### AMEPVH013

holds four Ibidi 35mm Petri dishes

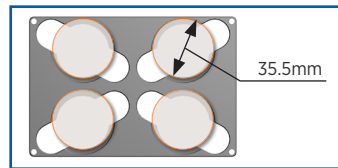

### AMEPVH007

holds one Hemocytometer

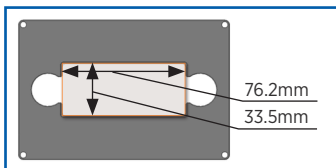

### AMEPVH014

holds two Ibidi 50mm Petri dishes

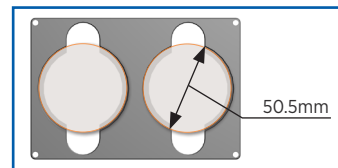

## FL, FL Color & XL

### AMEP4684

Stage Plate for heating tray, Tokai Hit #MATS-UAXKW-D

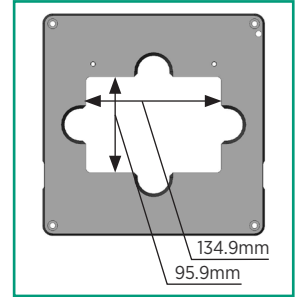

### AMEP4685

Stage Plate for heating stage, BioFlux by Fluxion

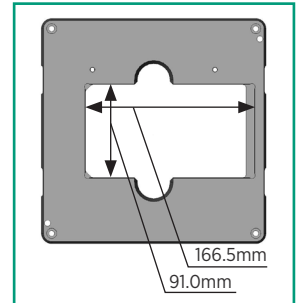

### AMEP4686

Stage Plate for multiwell vessels; also holds one Corning T-75 flask

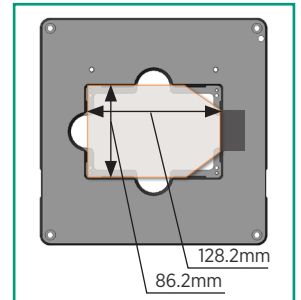

### AMEP4691

Stage Plate with 110m x 160m opening (Use with AMEP4692 for standard sizes)

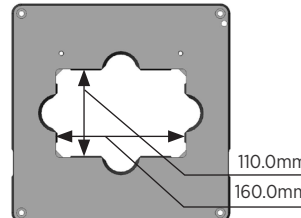

### AMEP4692

Stage Plate Adaptor 110mm x 160mm opening for standard size (sold separately)

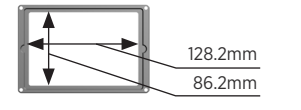

## FL Auto

### AMEPVH021

Securely holds two 25mm x 75mm standard microscope slides, chamber slides, etc.

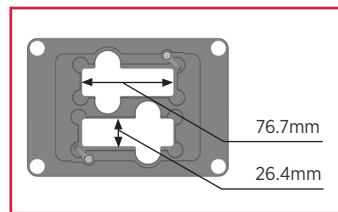

### AMEPVH022

Intermediate Plate for Automated Stage. Securely holds multiwell vessels with convenient lever Adaptor for AMEPVH001 and AMEPVH009

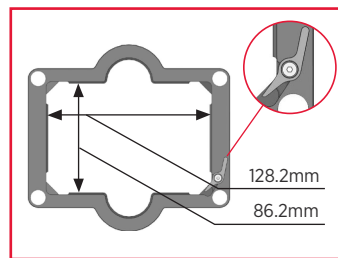

### AMEPVH023

holds multiwell vessels Adaptor for AMEPVH001 and AMEPVH009

